



**FAHRZEUG-  
EINRICHTUNGEN**

**FITTINGS FOR  
COMMERCIAL VEHICLES**



**FORD TRANSIT CONNECT**



## STORE VAN ORANGE PLANET - STOREVAN ORANGE PLANET

**STORE VAN ORANGE PLANET**

Nachhaltigkeit und ökologische Entwicklung sind Themen von großem, aktuellem Interesse, entstanden durch das steigende Bewusstsein, dass auf die Umweltbalance aufgrund der zyklischen Veränderungen und Erneuerungen geachtet werden muss.

**STORE VAN ORANGE PLANET**

Environmental sustainability and eco-compatible development are topics of great interest and relevance, arising from the growing awareness that it is important to pay attention to the environmental balance.

## ZERTIFIZIERUNGEN - CERTIFICATIONS

**ZERTIFIZIERTE PRODUKTION**

- Nach ISO 9001:2008 zertifiziert.
- Erfolgreicher CRASH TEST durchgeführt nach ECE-R17 mit einer Aufprallgeschwindigkeit von 50 Km/h.
- GS-Zertifizierung für Inneneinrichtungen und Laderampen.
- GS-Zertifizierung für Dachträger und Leiterträger.

**CERTIFIED PRODUCTION**

- ISO 9001:2008 certified.
- Brilliantly passed the CRASH TEST carried out according to the most recent European regulations ECE-R17 with impact at 50 Km/h.
- GS certification for interior fittings and loading ramps.
- GS certification for roof and ladder racks.



**CRASH TEST**  
ECE-R17





**StoreVan ist weltweit der einzige Hersteller von Nutzfahrzeugeinrichtungen, der mit dieser Technologie arbeitet.**

**StoreVan is the sole LCV's equipment manufacturer worldwide to make use of this technology.**



#### **GALVANNEALED STAHL**

Galvannealed Blech ist eine Variante von feuerverzinktem Blech. Das Produkt unterliegt einem Feuerbeschichtungsprozess und wird bis ca. 550 °C erhitzt. Dies ermöglicht es dem Zink mit dem Stahlblech eine Legierung einzugehen. Das Ergebnis ist eine Beschichtung mit einer gleichförmigen, feinkörnigen Kristallstruktur an der Beschichtungsoberfläche und einer **sehr hohen Oberflächenqualität und Korrosionsbeständigkeit**. Dieses Verfahren ist ideal für Automotive Anwendungen. StoreVan hat diese Technik nun auch im Bereich Nutzfahrzeugeinrichtungen implementiert.

#### **DAS VERFAHREN DER KATHODISCHEN ACRYL-TAUCHLACKIERUNG**

Die kathodische Acryl-Beschichtung ist eine Oberflächenbehandlung, die den einzelnen Teilen der Einrichtung eine **extrem hohe Korrosionsbeständigkeit** verleiht. Das Tauchverfahren gewährleistet eine **gleichmäßige Beschichtung** und einen lang anhaltenden Schutz egal gegen welche Stoffe. Das Acrylharz schützt den Lack bei direkter Belichtung durch die Witterung gegen Ausbleichen und gegen Veränderungen der Korrosionsbeständigkeit.

- Korrosionsbeständigkeit von über 500 Stunden (ASTM D1735 Luftfeuchtigkeit)
- Ausgezeichnete Härte mit einem Mindestrating von 2H



#### **GALVANNEALED STEEL**

Galvannealed sheet is a variant of hot-dip galvanized sheet. The product is subject to a hot-dip-galvanization process and subsequently heated to approximately 550°C, combining the zinc with the sheet surface to make an alloy with iron. The result is a uniform zinc coating with a fine-grained crystalline structure along with a **much higher surface quality and corrosion resistance**. This process is ideal for automotive applications. StoreVan introduced and implemented this technology in the commercial vehicles equipment field.

#### **CATHODIC DIP PAINTING WITH ACRYLIC RESIN**

Cataphoresis painting is a paint surface treatment able to give the equipment elements a **remarkable resistance to corrosion**; characterized by **uniform deposit** of an acrylic resin on the element surface, it ensures long lasting and high protection against chemical agents and other types of surface attacks. The acrylic resin allows a direct exposure to atmospheric agents without altering its technical features. This process ensures an increased protection against rust.

- Corrosion resistance of more than 500 hours (humidity ASTM D1735)
- Excellent hardness with a minimum rating of 2H







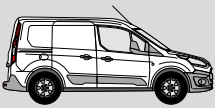

# FORD TRANSIT CONNECT

KASTENWAGEN - PANEL VAN

## BODENPLATTE UND SEITENVERKLEIDUNGEN - FLOORING AND LININGS

- Bodenplatte und Seitenverkleidungen für Fahrzeug mit rechter Schiebetür und Seitenwänden aus Vollblech.
- Flooring and linings for right side door vehicle with metal sheet sidewalls.

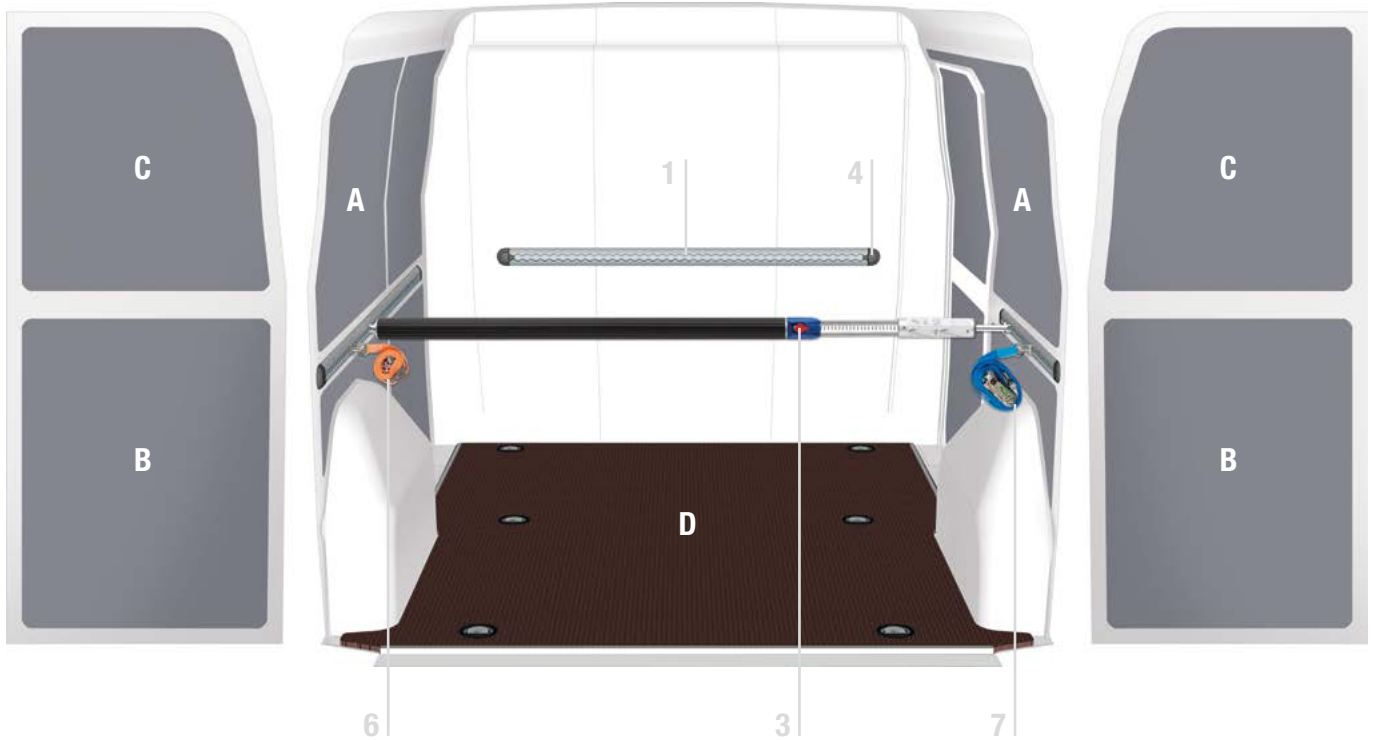

FAHRZEUG VEHICLE	BODENPLATTE 12 mm 12 mm FLOORING	SEITENVERKLEIDUNG LINING	SEITENVERKLEIDUNG LINING
	D	A+B	C
	ART. NR. / ITEM NO.	ART. NR. / ITEM NO.	ART. NR. / ITEM NO.
Fahrzeugtyp - Model L1 H1 <sup>A</sup>	<b>PIL 315</b> 18,66 kg	<b>PAN 314</b> 6,02 kg	<b>PAR 307</b> 1,10 kg
Fahrzeugtyp - Model L1 H1 <sup>B</sup>	<b>PIL 313</b> 16,23 kg	<b>PAN 310</b> 5,11 kg	<b>PAR 307</b> 1,10 kg
Fahrzeugtyp - Model L2 H1 <sup>A</sup>	<b>PIL 316</b> 22,96 kg	<b>PAN 315</b> 7,67 kg	<b>PAR 307</b> 1,10 kg
Fahrzeugtyp - Model L2 H1 <sup>B</sup>	<b>PIL 314</b> 20,20 kg	<b>PAN 311</b> 6,37 kg	<b>PAR 307</b> 1,10 kg

<sup>A</sup> Basisversion - Version Base

<sup>B</sup> Version Trend - Version Trend

## BODENPLATTE UND SEITENVERKLEIDUNGEN - FLOORING AND LININGS

**PAN**

- Seitenverkleidung aus Polypropylen für:
  - linke Seitenwand
  - rechte Seitenwand und Schiebetür
  - unteren Teil der Heckflügeltüren
- Polypropylene linings for:
  - LH sidewall
  - RH sidewall and sliding door
  - lower part of rear hinged doors

**PAR**

- Seitenverkleidung aus Polypropylen für:
  - oberen Teil der Heckflügeltüren
- Polypropylene linings for:
  - upper part of rear hinged doors

**PIL**

- Bodenplatte aus Multiplex mit Phenolbeschichtung, Stärke 12 mm, für das Originalverankerungssystem des Fahrzeugs vorgebohrt.
- 12 mm thick wooden flooring with phenolic coating set for the vehicles original anchoring system

## LADUNGSSICHERUNG - LOAD SECURING

**BESCHREIBUNG - DESCRIPTION**

- Horizontale Aluschiene.
- Horizontal aluminium bar.

**ALUSCHIENE - BAR**

1

**LÄNGE - LENGTH**

ART. NR. / ITEM NO. F 22 FC V18029 05 00	500 mm
ART. NR. / ITEM NO. F 22 FC V18029 10 00	1000 mm
ART. NR. / ITEM NO. F 22 FC V18029 15 00	1500 mm
ART. NR. / ITEM NO. F 22 FC V18029 20 00	2000 mm
ART. NR. / ITEM NO. F 22 FC V18029 25 00	2500 mm

**BESCHREIBUNG - DESCRIPTION**

- Horizontale Aluschiene für Seitenwände.
- Horizontal aluminium bar for side panels.

**ALUSCHIENE - BAR**

2

**LÄNGE - LENGTH**

ART. NR. / ITEM NO. F 22 FC V18025 05 00	500 mm
ART. NR. / ITEM NO. F 22 FC V18025 10 00	1000 mm
ART. NR. / ITEM NO. F 22 FC V18025 15 00	1500 mm

**BESCHREIBUNG - DESCRIPTION**

- Teleskopische Spannstanze.
- Telescopic load restraining bar.

**STANGE - BAR**

3

**HÖHE - HEIGHT**

ART. NR. / ITEM NO. F 22 FC V22149 00 00	650-900 mm
ART. NR. / ITEM NO. F 22 FC V22131 00 00	1250-1750 mm
ART. NR. / ITEM NO. F 22 FC V22017 00 00	1550-2050 mm

**BESCHREIBUNG - DESCRIPTION**

- Endstück aus Kunststoff für Aluschiene Serie V18029.
- Plastic end cap for bar series V18029.

**ENDSTÜCK FÜR ALUSCHIENE - PLASTIC END CAP FOR BAR**

4

ART. NR. / ITEM NO. F 22 FC V22106 00 00

**BESCHREIBUNG - DESCRIPTION**

- Zurring.
- Ring stud fitting.

**ZURRRING - RING STUD FITTING**

5

ART. NR. / ITEM NO. F 22 FC V22090 00 00

**BESCHREIBUNG - DESCRIPTION**

- Zurring mit Hebelspannschloss 2500+500.
- Load restraining belt with clamp 2500+500.

**ZURRGURT - BELT**

6

ART. NR. / ITEM NO. F 22 FC V22136 00 00

**BESCHREIBUNG - DESCRIPTION**

- Zurring mit Ratschenschloss 2500+500.
- Load restraining belt with ratchet 2500+500.

**ZURRGURT - BELT**

7

ART. NR. / ITEM NO. F 22 FC V22124 00 00

Für weitere Informationen fordern Sie bitte unseren „Ladungssicherung“ - Katalog an

For more information, ask for our “Load Securing” catalogue





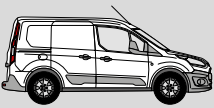

## FAHRZEUGEINRICHTUNGSBEISPIELE - FITTINGS EXAMPLES

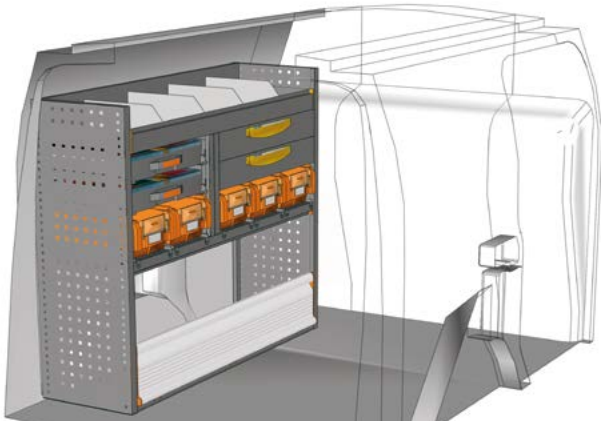

BEISPIEL - EXAMPLE

CN 1210 01\*

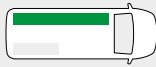

B=1225 T=365 H=1000 mm - W=1225 D=365 H=1000 mm

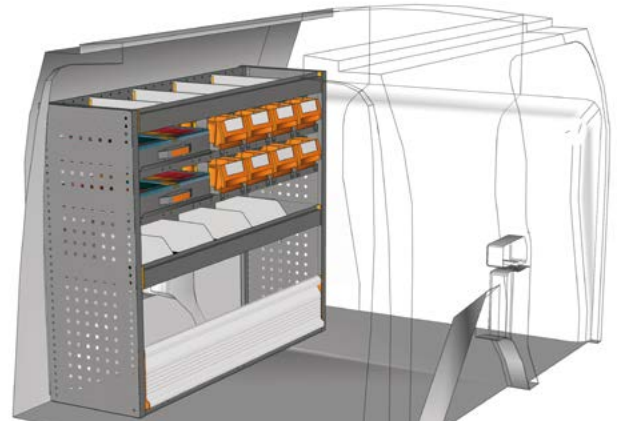

BEISPIEL - EXAMPLE

CN 1210 02\*

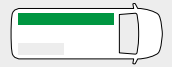

B=1225 T=365 H=1000 mm - W=1225 D=365 H=1000 mm

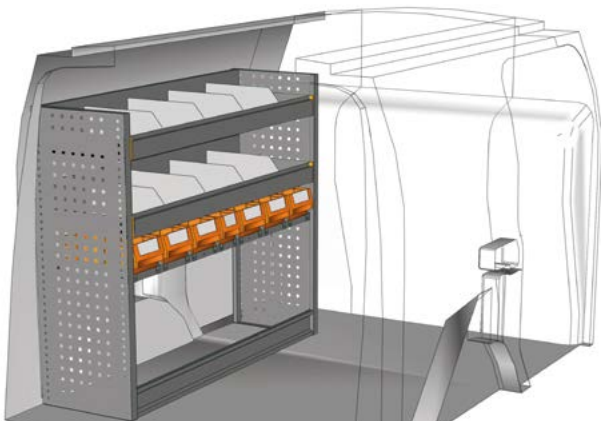

BEISPIEL - EXAMPLE

CN 1210 03\*

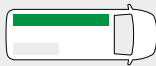

B=1225 T=365 H=1000 mm - W=1225 D=365 H=1000 mm

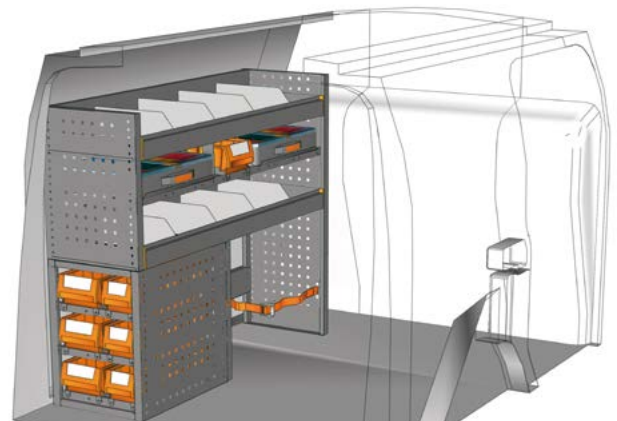

BEISPIEL - EXAMPLE

CN 1210 04\*

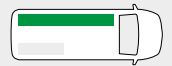

B=1225 T=365 H=1000 mm - W=1225 D=365 H=1000 mm

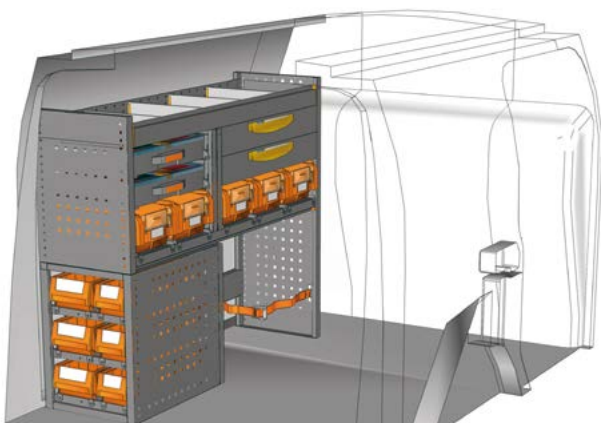

BEISPIEL - EXAMPLE

CN 1210 05\*

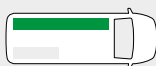

B=1225 T=365 H=1000 mm - W=1225 D=365 H=1000 mm

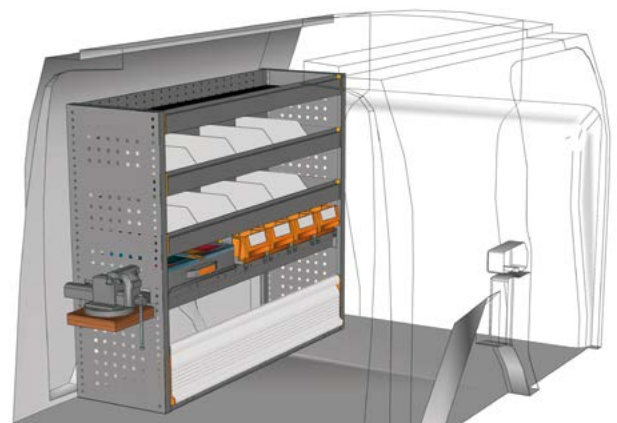

BEISPIEL - EXAMPLE

CN 1210 06\*

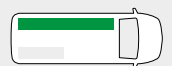

B=1225 T=365 H=1000 mm - W=1225 D=365 H=1000 mm





## FAHRZEUGEINRICHTUNGSBEISPIELE - FITTINGS EXAMPLES

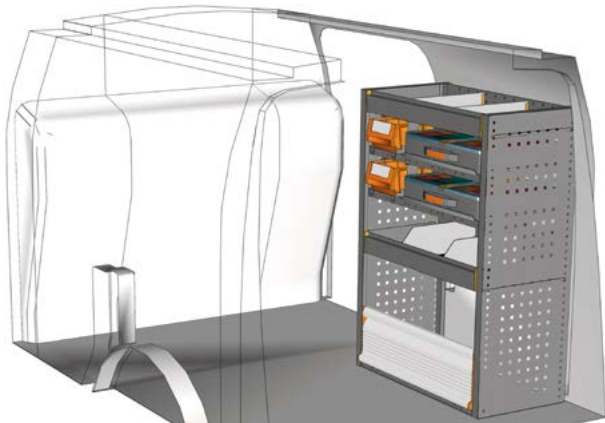

BEISPIEL - EXAMPLE

CN 0710 01\*

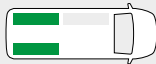

B=717 T=365 H=1000 mm - W=717 D=365 H=1000 mm

**Haben Sie Ihre Einrichtung nicht gefunden?  
Verlassen Sie sich auf die Profis für  
Fahrzeugeinrichtungen.**

Auf der Rückseite dieses Katalogs  
finden Sie die nächstgelegene  
StoreVan Niederlassung.  
Besuchen Sie unsere Web-Seite.



**Didn't find the equipment  
you're looking for?  
Leave it to our experts.**

See the back of this catalogue  
and contact the nearest  
StoreVan point or visit our website.

**\* Einschließlich Befestigungskit - Fixing kit included**

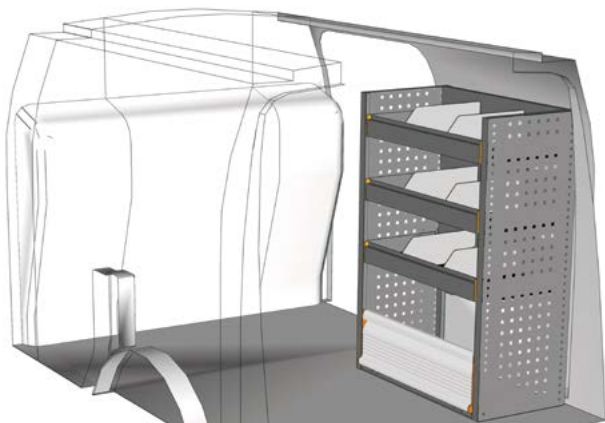

BEISPIEL - EXAMPLE

CN 0710 02\*

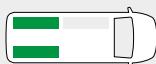

B=717 T=365 H=1000 mm - W=717 D=365 H=1000 mm

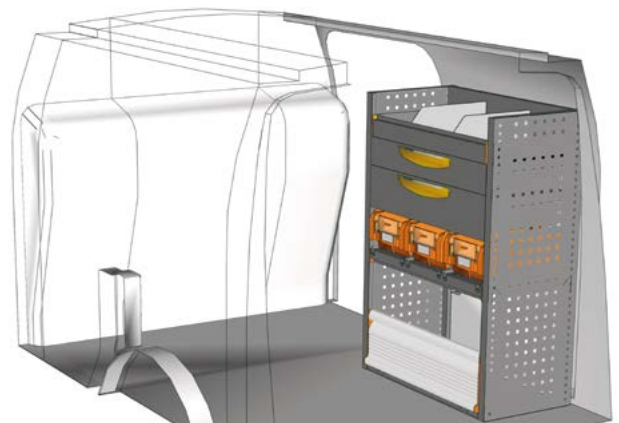

BEISPIEL - EXAMPLE

CN 0710 03\*

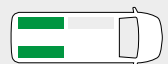

B=717 T=365 H=1000 mm - W=717 D=365 H=1000 mm



BEISPIEL - EXAMPLE

CN 0710 04\*

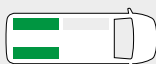

B=717 T=365 H=1000 mm - W=717 D=365 H=1000 mm

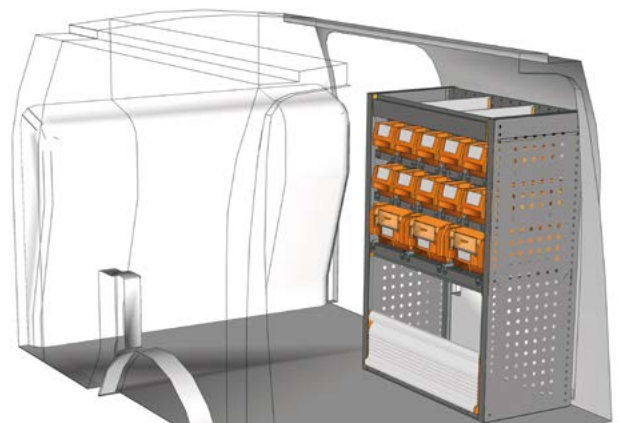

BEISPIEL - EXAMPLE

CN 0710 05\*

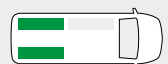

B=717 T=365 H=1000 mm - W=717 D=365 H=1000 mm

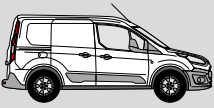

## FAHRZEUGEINRICHTUNGSBEISPIELE - FITTINGS EXAMPLES

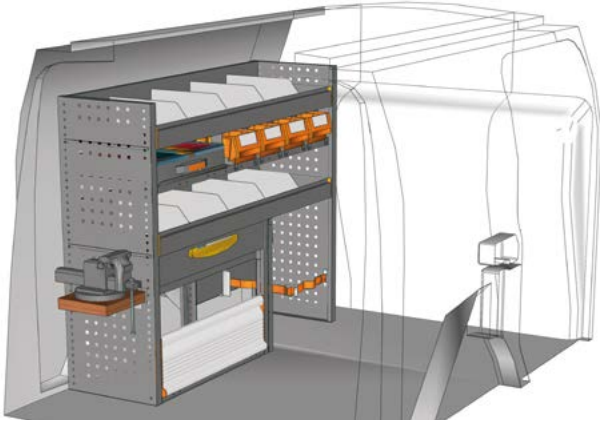

BEISPIEL - EXAMPLE

CN 1210 07\*

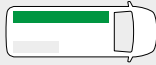

B=1225 T=365 H=1000 mm - W=1225 D=365 H=1000 mm

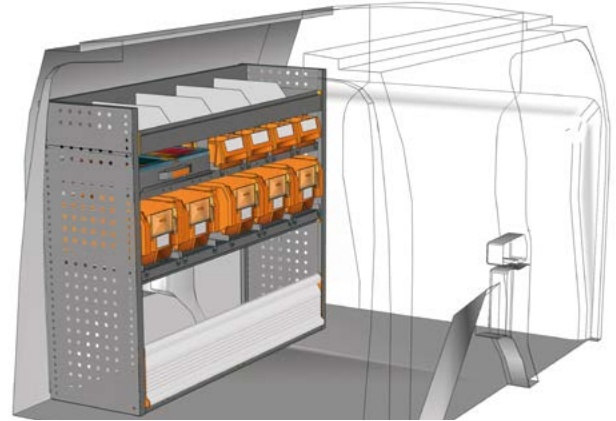

BEISPIEL - EXAMPLE

CN 1210 08\*

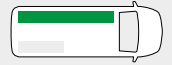

B=1225 T=365 H=1000 mm - W=1225 D=365 H=1000 mm

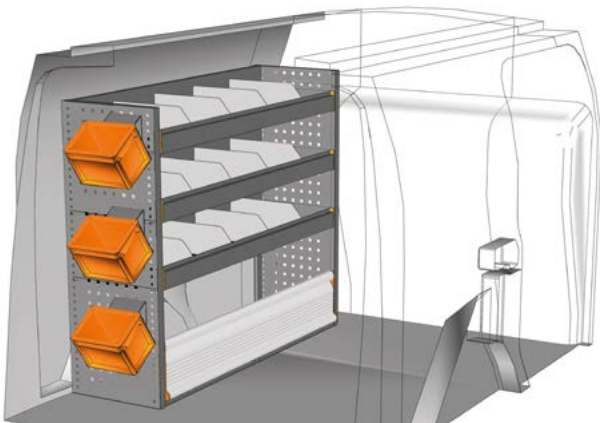

BEISPIEL - EXAMPLE

CN 1210 09\*

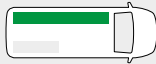

B=1225 T=365 H=1000 mm - W=1225 D=365 H=1000 mm

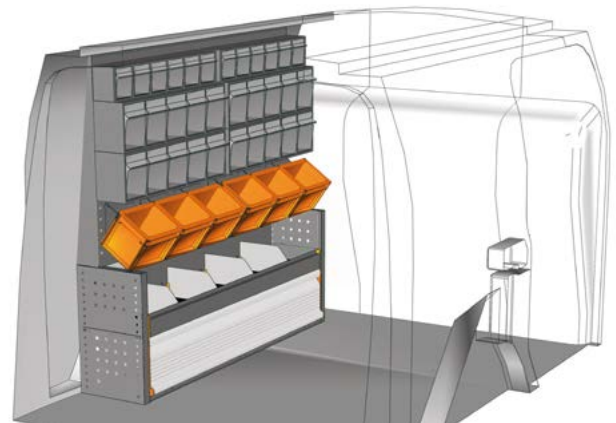

BEISPIEL - EXAMPLE

CN 1211 01\*

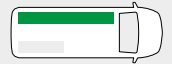

B=1225 T=265 H=1150 mm - W=1225 D=265 H=1150 mm

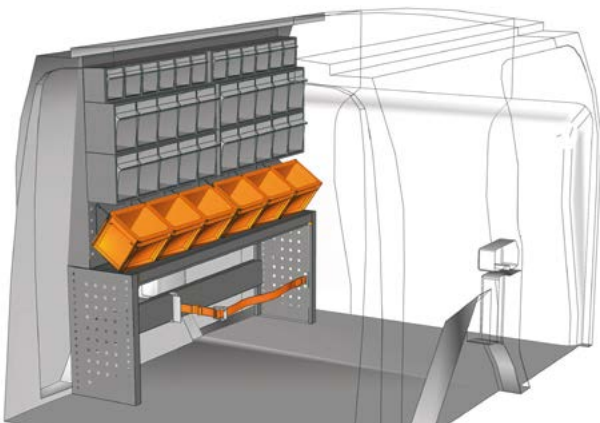

BEISPIEL - EXAMPLE

CN 1211 02\*

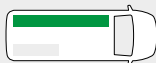

B=1225 T=265 H=1150 mm - W=1225 D=265 H=1150 mm

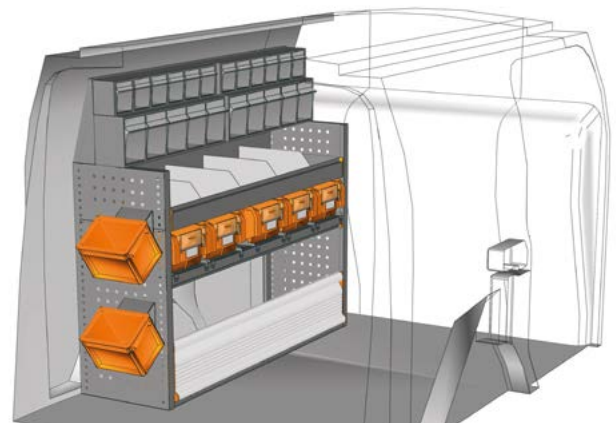

BEISPIEL - EXAMPLE

CN 1211 03\*

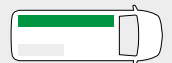

B=1225 T=365 H=1080 mm - W=1225 D=365 H=1080 mm



FAHRZEUGEINRICHTUNGSBEISPIELE - FITTINGS EXAMPLES

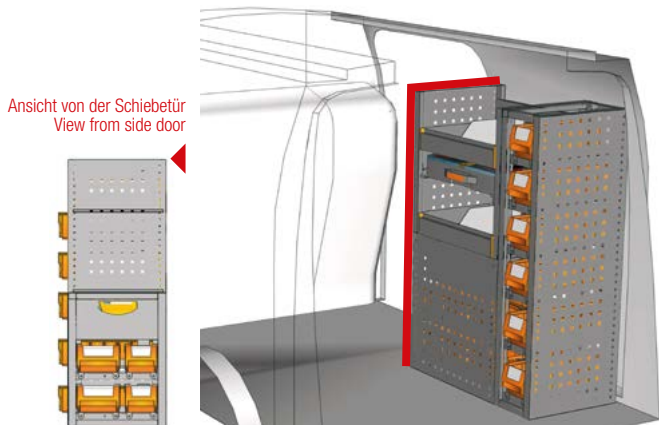

Ansicht von der Schiebetür  
View from side door

BEISPIEL - EXAMPLE

CN 0710 06\*

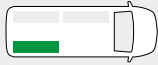

B=717 T=365 H=1000 mm - W=717 D=365 H=1000 mm

**Haben Sie Ihre Einrichtung nicht gefunden?  
Verlassen Sie sich auf die Profis für  
Fahrzeugeinrichtungen.**

Auf der Rückseite dieses Katalogs  
finden Sie die nächstgelegene  
StoreVan Niederlassung.  
Besuchen Sie unsere Web-Seite.



**Didn't find the equipment  
you're looking for?  
Leave it to our experts.**

See the back of this catalogue  
and contact the nearest  
StoreVan point or visit our website.

**\* Einschließlich Befestigungskit - Fixing kit included**

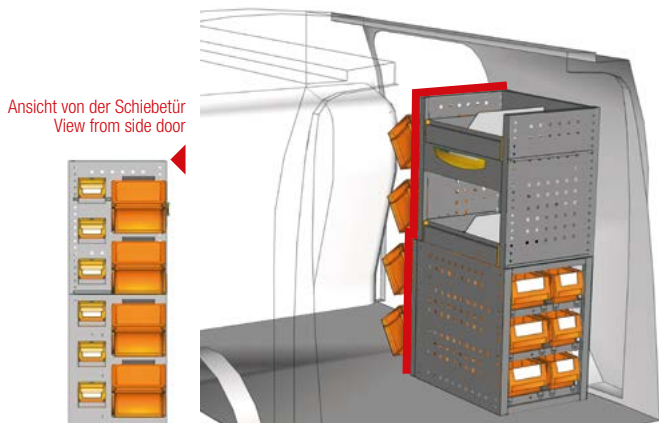

Ansicht von der Schiebetür  
View from side door

BEISPIEL - EXAMPLE

CN 0510 01\*

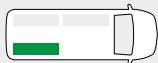

B=508 T=365 H=1000 mm - W=508 D=365 H=1000 mm

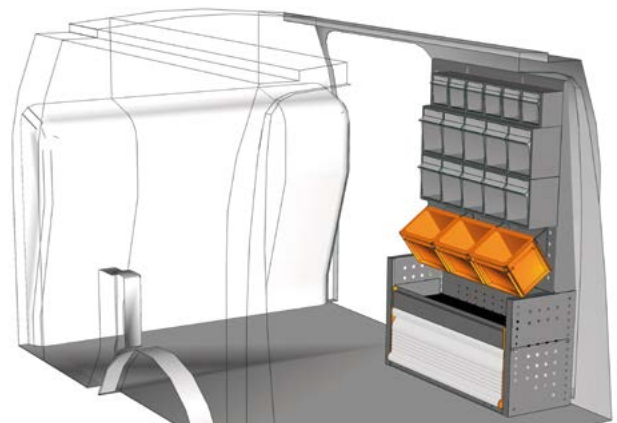

BEISPIEL - EXAMPLE

CN 0711 01\*



B=717 T=265 H=1100 mm - W=717 D=265 H=1100 mm

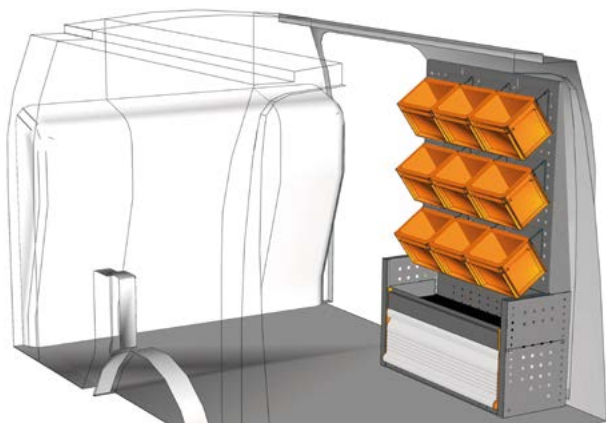

BEISPIEL - EXAMPLE

CN 0711 02\*

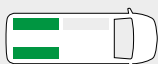

B=717 T=265 H=1100 mm - W=717 D=265 H=1100 mm

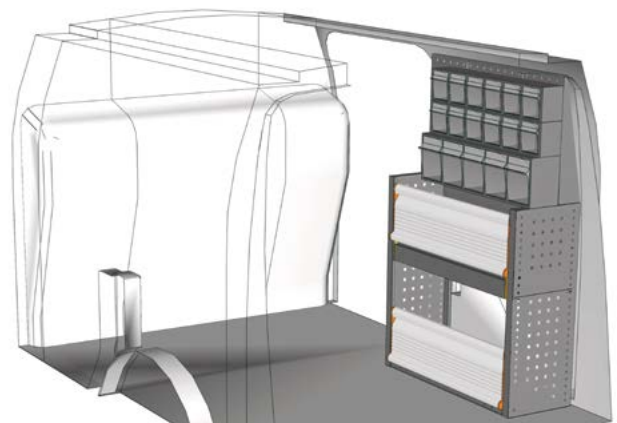

BEISPIEL - EXAMPLE

CN 0711 03\*

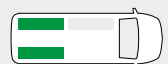

B=717 T=265 H=1120 mm - W=717 D=265 H=1120 mm



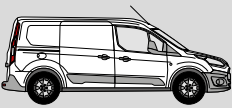

FAHRZEUGEINRICHTUNGSBEISPIELE - FITTINGS EXAMPLES

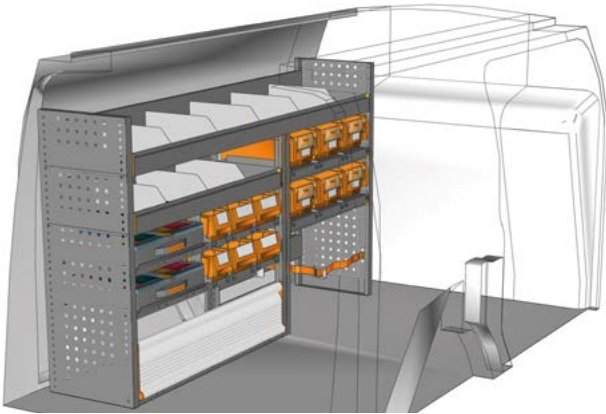

BEISPIEL - EXAMPLE

CN 1710 01\*

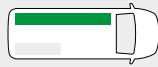

B=1733 T=365 H=1000 mm - W=1733 D=365 H=1000 mm

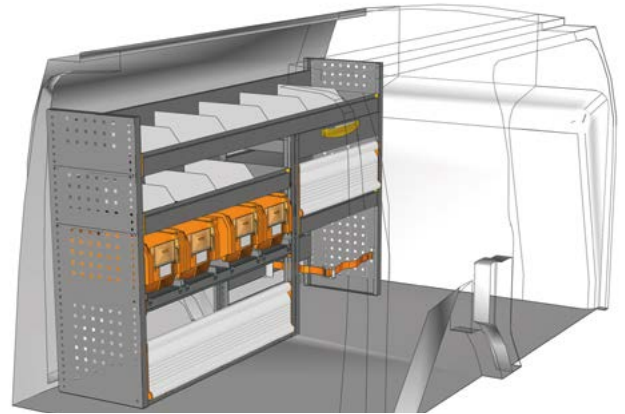

BEISPIEL - EXAMPLE

CN 1710 02\*

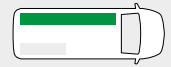

B=1733 T=365 H=1000 mm - W=1733 D=365 H=1000 mm

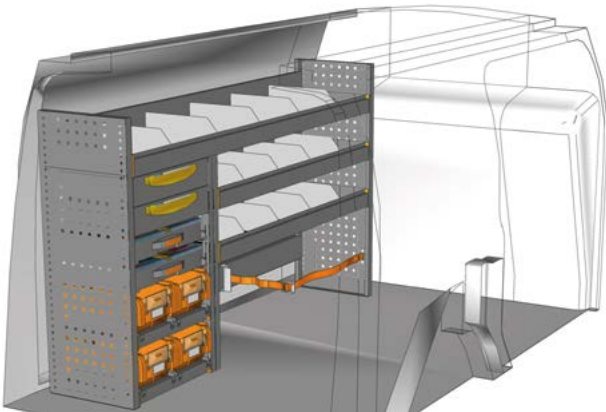

BEISPIEL - EXAMPLE

CN 1710 03\*

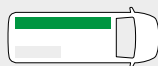

B=1733 T=365 H=1000 mm - W=1733 D=365 H=1000 mm

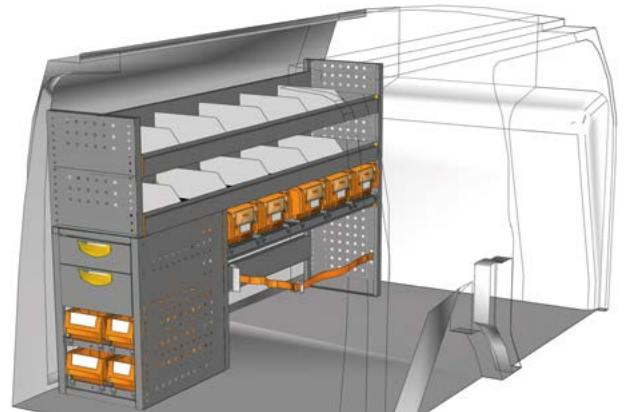

BEISPIEL - EXAMPLE

CN 1710 04\*

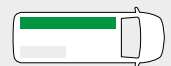

B=1733 T=365 H=1000 mm - W=1733 D=365 H=1000 mm

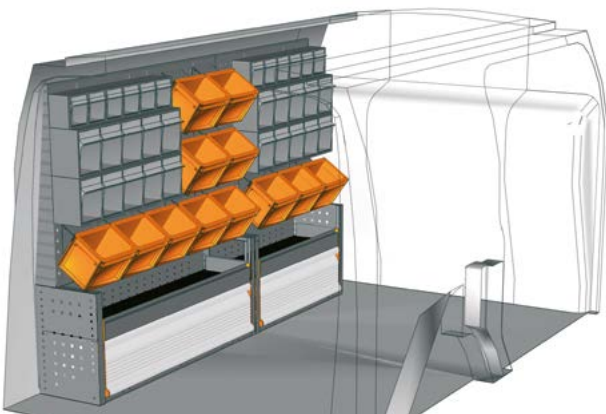

BEISPIEL - EXAMPLE

CN 1711 01\*

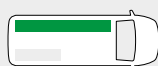

B=1733 T=265 H=1100 mm - W=1733 D=265 H=1100 mm

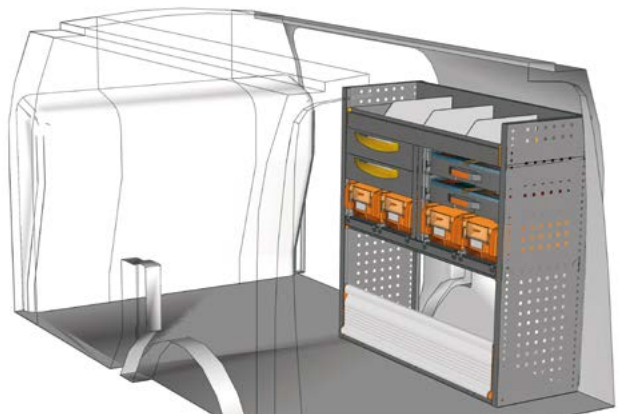

BEISPIEL - EXAMPLE

CN 1010 01\*

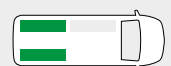

B=1016 T=365 H=1000 mm - W=1016 D=365 H=1000 mm



FAHRZEUGEINRICHTUNGSBEISPIELE - FITTINGS EXAMPLES

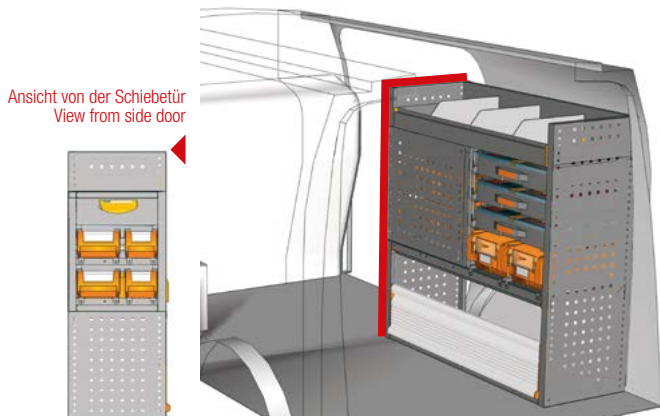

BEISPIEL - EXAMPLE

CN 1010 02\*

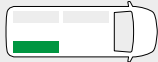

B=1016 T=365 H=1000 mm - W=1016 D=365 H=1000 mm

**Haben Sie Ihre Einrichtung nicht gefunden?  
Verlassen Sie sich auf die Profis für  
Fahrzeugeinrichtungen.**

Auf der Rückseite dieses Katalogs  
finden Sie die nächstgelegene  
StoreVan Niederlassung.  
Besuchen Sie unsere Web-Seite.



**Didn't find the equipment  
you're looking for?  
Leave it to our experts.**

See the back of this catalogue  
and contact the nearest  
StoreVan point or visit our website.

**\* Einschließlich Befestigungskit - Fixing kit included**

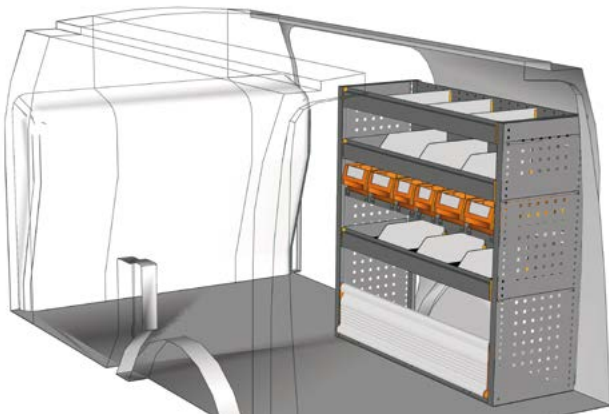

BEISPIEL - EXAMPLE

CN 1010 04\*



B=1016 T=365 H=1000 mm - W=1016 D=365 H=1000 mm

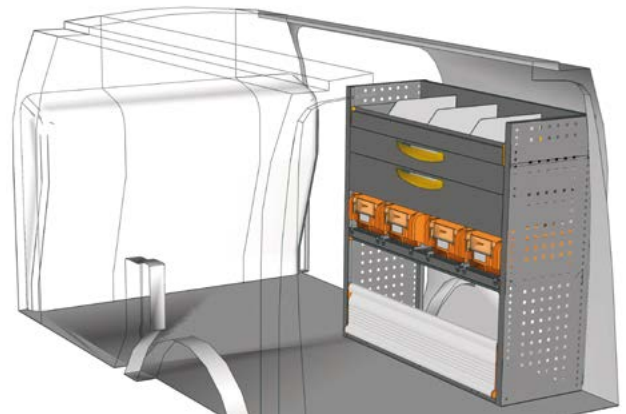

BEISPIEL - EXAMPLE

CN 1010 05\*

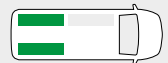

B=1016 T=365 H=1000 mm - W=1016 D=365 H=1000 mm

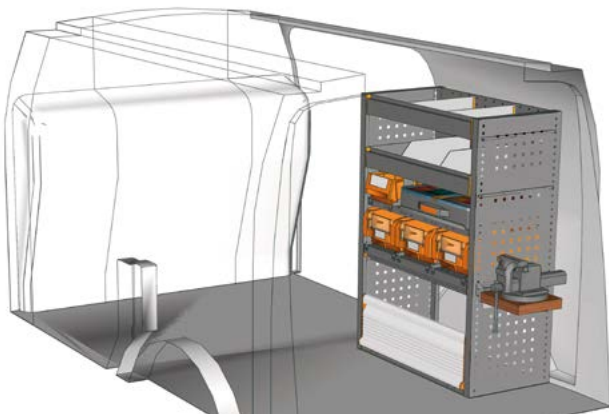

BEISPIEL - EXAMPLE

CN 0710 08\*

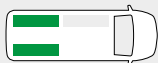

B=717 T=365 H=1000 mm - W=717 D=365 H=1000 mm

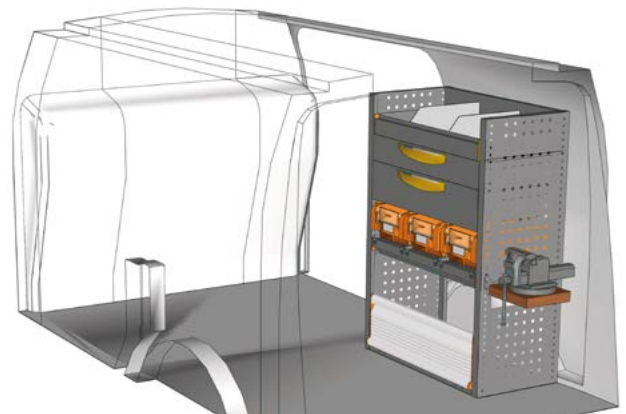

BEISPIEL - EXAMPLE

CN 0710 09\*

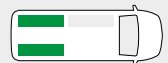

B=717 T=365 H=1000 mm - W=717 D=365 H=1000 mm







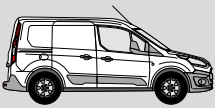

# FORD TRANSIT CONNECT

KASTENWAGEN - PANEL VAN



## DACHTRÄGER UND LEITERTRÄGER - ROOF AND LADDER RACK



FAHRZEUG VEHICLE	DACHTRÄGER ROOF RACK	ABMESSUNGEN DIMENSIONS	GEWICHT WEIGHT	TRAGKRAFT LOAD CAPACITY
	ART. NR. / ITEM NO.			
Fahrzeugtyp - Model L1 H1	POT 312	1800x1400 mm	20,79 kg	79,00 kg
Fahrzeugtyp - Model L2 H1	POT 313	2250x1400 mm	26,44 kg	73,00 kg

- Nur für Fahrzeug mit Heckflügeltüren.
- Only for vehicle with rear leaf doors.

### POT

- Dachträger bestehend aus:
  - Alu-Querschienen inkl. Befestigungen und Gummiprofilen
  - Seitenwänden aus Aluminium
  - Laderolle aus Aluminium
  - Schraubmaterial aus Edelstahl
- Roof rack complete of:
  - aluminium crossbars with fixing parts and rubber profile
  - aluminium side rails
  - aluminium loading roller
  - fixing screws in stainless steel

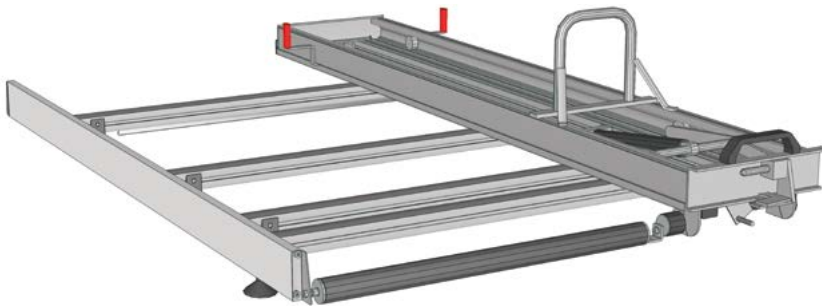

FAHRZEUG VEHICLE	LEITERTRÄGER LADDER RACK	ABMESSUNGEN DIMENSIONS	GEWICHT WEIGHT	TRAGKRAFT LOAD CAPACITY
	ART. NR. / ITEM NO.			
Fahrzeugtyp - Model L1 H1	POS 312	2110x1380 mm	45,76 kg	54,00 kg
Fahrzeugtyp - Model L2 H1	POS 313	2250x1380 mm	50,41 kg	49,00 kg

- Nur für Fahrzeug mit Heckflügeltüren. Der Leiterträger kann links oder rechts montiert werden.
- Only for vehicle with rear leaf doors. The ladder rack rail can be mounted on the right or left side.

### POS

- Leiterträger bestehend aus:
  - Alu-Querschienen inkl. Befestigungen und Gummiprofilen
  - Seitenwand aus Aluminium
  - Laderolle aus Aluminium
  - Leiterschiene aus Aluminium und Edelstahl
  - Schraubmaterial aus Edelstahl
- Ladder rack complete of:
  - aluminium crossbars with fixing parts and rubber profile
  - aluminium side rail
  - aluminium loading roller
  - ladder rack rail made of aluminium and stainless steel
  - fixing screws in stainless steel





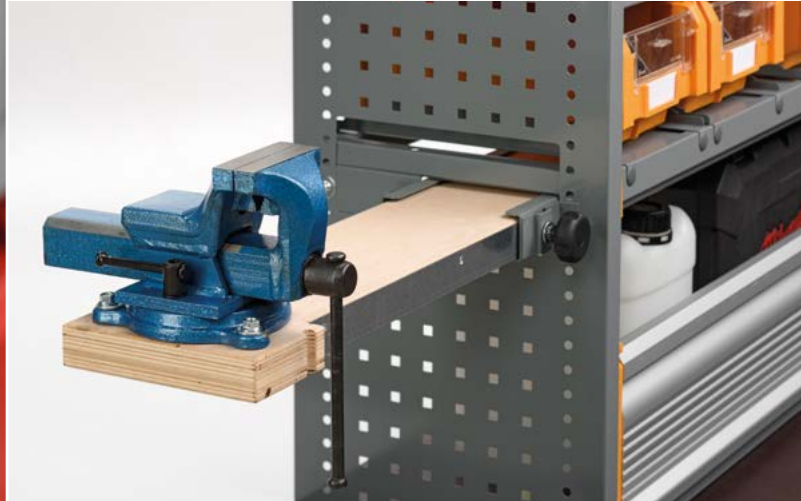



## ZUBEHÖR - ACCESSORIES



ART. NR. / ITEM NO. ACS 005

- Papierrollen-Kit Ø 140 mm
- Paper roll holder Ø 140 mm



ART. NR. / ITEM NO. ACS 012

- Papierrollen-Kit Ø 240 mm
- Paper roll holder Ø 240 mm



ART. NR. / ITEM NO. ACS 013

- Silikonträgersatz
- Silicone holder kit



ART. NR. / ITEM NO. ACS 014

- Schlauchhalter
- Cable holder



ART. NR. / ITEM NO. ACS 004

- Erste-Hilfe-Kasten
- First aid kit



ART. NR. / ITEM NO. ACS 006

- Plantasche für DIN A4 Formate
- DIN A4 pocket document holder



ART. NR. / ITEM NO. ACS 007

- Spraydosenhalter
- Spray can holder



ART. NR. / ITEM NO. ACS 015

- Halterung mit 1 Behälter Größe 1PL
- Holder with 1 container mesure 1 PL



ART. NR. / ITEM NO. ACS 016

- Halterung mit 3 Behältern Größe 1PL
- Holder with 3 containers mesure 1 PL



ART. NR. / ITEM NO. ACS 017

- Halterung mit Behälter Größe 2115A
- Holder with box mesure 2115A



ART. NR. / ITEM NO. ACS 001

- Handwasch-Kit
- Hand wash kit



ART. NR. / ITEM NO. ACS 002

- Kanisterhalter mit Kanister Inh. 20 Lt.
- Jerrycan holder with 20 litres iron jerrycan

## ZUBEHÖR - ACCESSORIES

**ART. NR. / ITEM NO. ACS 003**
**A**

- Halterung mit Gurt für Flaschen und Feuerlöscher
- Holder with belt for gas cylinders and extinguishers

**ART. NR. / ITEM NO. ACS 018**
**B**

- Feuerlöscher 4 kg
- Fire extinguisher 4 kg

**ART. NR. / ITEM NO. ACS 019**

- All Safe Stange L=365 mm und Zurrurt mit Ratschenschloss
- All Safe bar L= 365 mm and ratchet belt

**ART. NR. / ITEM NO. ACS 020**
**C**

- All Safe Stange L=445 mm und Zurrurt mit Ratschenschloss
- All Safe bar L= 445 mm and ratchet belt

**ART. NR. / ITEM NO. ACS 021**

- All Safe Stange L=365 mm und Zurrurt mit Hebelspannschloss
- All Safe bar L= 365 mm and clamp belt

**ART. NR. / ITEM NO. ACS 022**
**D**

- All Safe Stange L=445 mm und Zurrurt mit Hebelspannschloss
- All Safe bar L= 445 mm and clamp belt

 Beispiel mit 2 **ART. NR. ACS 003**  
 Example with 2 **ITEMS NO. ACS 003**

 Beispiel mit 2 **ART. NR. ACS 019**  
 Example with 2 **ITEMS NO. ACS 019**

 Beispiel mit 2 **ART. NR. ACS 021**  
 Example with 2 **ITEMS NO. ACS 021**

**ART. NR. / ITEM NO. ACS 023**

- Satz 10 Magnete Ø 20 mm
- Set of 10 magnets Ø 20 mm

**ART. NR. / ITEM NO. ACS 024**

- Satz 10 Magnete Ø 25 mm
- Set of 10 magnets Ø 25 mm

**ART. NR. / ITEM NO. ACS 025**

- LED-Lampe L=600 mm IP20 12V
- LED lamp L=600 mm IP20 12V

#### LIEFERBEDINGUNGEN

- Bodenplatten und Seitenverkleidungen werden in mehreren Teilen geliefert.
- Dachträger und Leiterträger werden **lose** geliefert.
- Module werden **vormontiert** komplett mit Fahrzeugbefestigungsmaterial geliefert.
- Produkte sollen vorzugsweise von **Vertragshändlern** installiert werden.
- Produkte werden **verpackt** geliefert.
- **3 Jahre Garantie** auf unsere Komponenten.
- Die Tragkräfte beziehen sich auf **gleichmäßig verteilte Last**.

#### SUPPLY CONDITIONS

- Flooring and linings supplied in several pieces.
- Roof and ladder racks supplied **flat-packed**.
- Modules are supplied **preassembled** complete of fixing material to the vehicle.
- For products installation, please get in touch with our **approved installer's network**.
- Products provided **with packaging**.
- Our products are covered by a **3-years warranty**.
- Load capacities refer to **uniformly distributed loads**.

[WWW.STOREVAN.COM](http://WWW.STOREVAN.COM)



#### FAMI S.r.l.

Via Stazione Rossano, 13 | 36027 Rosà (VI) | ITALY  
phone +39 0424 585455 | fax +39 0424 585482  
[www.famisp.com](http://www.famisp.com) | [info@famisp.com](mailto:info@famisp.com)  
[www.storevan.com](http://www.storevan.com) | [info@storevan.com](mailto:info@storevan.com)